



**OUR  
TOP PRODUCTS  
FOR SECURING CARGO  
AND LIFTING TECHNOLOGY**

**KFI**   
**CARGO CONTROL**

**Your partner for expertise in**

Load Securing, lifting technology, testing service,  
occupational safety & hygiene, commercial vehicle spare parts

**[www.kfi-cargo.com](http://www.kfi-cargo.com)**

## LASHING STRAPS: AS INDIVIDUAL AS YOUR COMPANY



**In-house sewing workshop**

### Logo print and lettering on the strap:

Your personal print makes the lashing strap unique and also serves as advertising for your company.

### The facts:

- Logo print and lettering in 12 colours
- Many different strap colours to choose from (blue, red, yellow, green, etc.)
- Crafted with high-quality materials
- Custom branding in batches as small as 50 pieces

### Custom designs:

With an in-house sewing workshop, we are able to realise special customer requests and custom solutions promptly. In addition to the quality claim 'Made in Germany', your company name can be added to the label.

### Express service:

If the components you have ordered are in stock, they can be sent on the same day.

## LASHING STRAP, 2-PART with claw hook and ratchet, STF 350 daN

- 2500 daN straight tension / 5000 daN wrap-around tension
- TÜV-approved with GS symbol
- 50 mm wide
- Manufactured to DIN EN 12195-2:2000

	Order no.	Length
	00225420	8 m
	00225423	9 m
	00225426	10 m

## LASHING STRAP, 2-PART with claw hook and long-lever pull ratchet, STF 500 daN

- 2500 daN straight tension / 5000 daN wrap-around tension
- TÜV-approved with GS symbol
- 50 mm wide
- Manufactured to DIN EN 12195-2:2000

	Order no.	Length
	00225422	8 m
	00225425	9 m
	00225428	10 m

## LASHING STRAP, 1-PART with clamping lock

- 250 daN wrap-around tension
- TÜV-approved with GS symbol
- 25 mm wide
- Manufactured to DIN EN 12195-2:2000

	Order no.	Length
	ZG1.25KS6,0GE	6 m

## LASHING STRAP, 2-PART with claw hook and ratchet

- 1000 daN straight tension / 2000 daN wrap-around tension
- TÜV-approved with GS symbol
- 35 mm wide
- Manufactured to DIN EN 12195-2:2000

	Order no.	Length
	00256449	6 m 0.4/5.6 m

Lashing straps in any length, with any hook, for any load! Short and long ends and ratchets also available separately.

## THE NUMBER 1 ANTI-SLIP MAT

- Standard product for lightweight cargo
- PU-bound recycled rubber granulate
- Extreme improvement in the static and sliding friction coefficients
- **Sliding friction coefficient up to 0.92 $\mu$**   
(contact surface: wood pallet, phenolic ply flooring in acc. with VDI 2700 Part 14)
- The impact on the lashing devices is reduced and the required pre-tensioning is lower
- Elongation at break: min. 60% (DIN EN ISO 1798)

Rolls and custom cuts are available in thicknesses from 3.0 mm to 20.0 mm.

 **Made in Germany**

Available at short notice  
**Anti-slip mats**  
All dimensions  
up to 50,000 pieces



Roll	Material thickness	Dimensions mm	
Order no.	mm	Width	Length
9500008	3	250	5000
9500001	8	250	5000



Custom cut	Material thickness	Dimensions mm	
Order no.	mm	Width	Length
9500022	3	100	200
9500004	8	100	200

## BELT NETS, CARGO SECURING NETS AND TARPAULINS available on request

### ▪ Belt nets



### ▪ Cargo securing nets

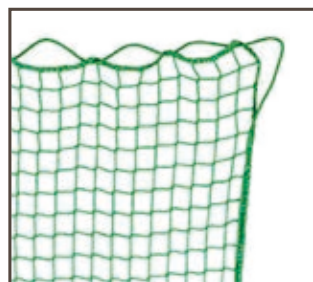

### ▪ Tarpaulins



## LASHING CHAINS WITH SHORTENING HOOKS, LENGTH 3 M

- In acc. with DIN EN 12195-3
- Stable, powder-coated hook
- With ratchet load tightener, tensioning range 160 mm
- Shortening hook for rapid length adjustment
- **Lashing chains with shortening claw available on request!**

Chain fixed 	Order no.		Chain	Lashing capacity	Tension force
	Chain fixed	Chain loose	Ø mm	LC daN	STF daN
Chain loose 	00228140	00226607	8	4000	1000
	00231108	00227767	10	6300	1575
	00226609	00230739	13	10000	1500
	00252041	00252045	16	16000	2400

## WELD-ON CLAMP/ANCHORAGE POINT

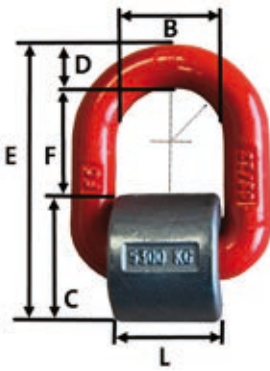
	Order no.	Load capacity	Dimensions mm					Weight	
		kg	B	C	D	E	F	L	kg
	00000493	1120	41	39	13	76	37	36	0.4
	00000494	2000	42	30	14	78	48	40	0.5
	00000495	3150	45	43	17	89	46	42	0.7
	00000496	5300	55	60	22	113	53	50	1.5
	00000497	8000	70	71	26	138	67	65	2.5
	00000498	15000	97	90	34	182	92	90	5.9

## EDGE PROTECTOR – STEEL

	Order no.	Side piece	Width	Strap guide
		mm	mm	mm
	00225377	90	125	70

## EDGE PROTECTOR – STEEL, HEAVY-DUTY

	Order no.	Side piece	Width	Strap guide
		mm	mm	mm
	00225360	124	158	50

**EDGE PROTECTOR – REINFORCED POLYETHYLENE – BLACK**

	<b>Order no.</b>	<b>Side piece</b>	<b>Width</b>	<b>Strap guide</b>
		mm	mm	mm
	00250941	90	135	Up to 100

**EDGE PROTECTOR – POLYPROPYLEN, HIGH-STABILITY – BLACK**

	<b>Order no.</b>	<b>Side piece</b>	<b>Width</b>	<b>Strap guide</b>
		mm	mm	mm
	00225374	175 / 136	150	70

**PAPER EDGE PROTECTOR**

- Especially for protecting paper rolls
- Equipped with a hole that enables simple connection during storage
- Resistant to very low and very high temperatures
- Received positive ratings in lab strength tests
- Perfectly matches the curve of the roll
- Provides optimal distribution of the pressure force of the lashing strap thanks to special design with one side piece elevated
- Complete lashing is possible without any damage to the roll or indentations in the paper

**EDGE PROTECTOR – ORANGE** Plastic, metre goods, max. 6 m

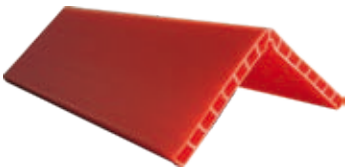
	<b>Order no.</b>	<b>Side piece</b>	<b>Weight</b>	<b>Material thickness</b>
		mm	kg/m	mm
	00229799	190	2.2	19

**EDGE PROTECTOR – BLACK** Polypropylen, thickness: 5 mm

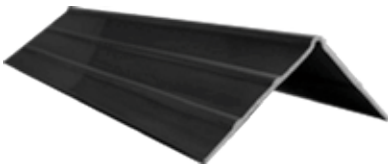

	<b>Order no.</b>	<b>Side piece</b>	<b>Weight</b>	<b>Length</b>
		mm	kg/m	mm
	00230005	160 / 130	4,0	2400

## PU EDGE PROTECTOR PLATES

Provides protection from mechanical damage, e.g. from sharp edges



	<b>Order no.</b>	<b>Thickness</b>	<b>Length</b>	<b>Width</b>	<b>Strap guide</b>
		mm	mm	mm	mm
	00225362	5	300	100	50

## PROTECTIVE HOSE 1 1/2" - Ø 38.1 mm - flat, 60 mm wide

	<b>Order no.</b>	<b>Material</b>	<b>Colour</b>	<b>for strap width</b>
				mm
	00226043	Polyester hose rubberised, highly flexible	Dark blue	50
	00226063	Polyester hose, rubberised on inside Reinforced with high-strength polyester yarn	Red	50

## STANCHION BOARD, V-PROFILE

Also available in other lengths!

<div style="display: flex; align-items: center;"> <div style="margin-right: 10px;"> <p><b>Branding</b></p>  </div>  </div>	<b>Order no.</b>	<b>Comments</b>	<b>Dimensions</b>
			mm
	00225392	Aluminium, V-profile, standard length 3.20 m	150x25

## Custom BRANDING for tensioning boards and stanchion boards

Available in batches as small as 50 pieces.

- Logo print and lettering in 12 colours
- Crafted with high-quality materials

### ALUMINIUM DECKING BEAM

Aluminium profile, load capacity: 1000 daN

Order no.	Adjustable range mm		Dimen- sions
	From	to	mm
00225379	2310	2530	66 x 84



### CARGO BAR

With rubber feet and spring

Order no.	Adjustable range mm		Dimen- sions
	From	to	mm
00225380	2350	2720	42 x 5



### SQUARE PARTING WALL LOCK

Steel, galvanised

Order no.	Adjustable range mm		Dimen- sions
	From	to	mm
00225378	1920	2720	40 x 40



### ROUND SHORING BEAM, COMBI PIN

Steel, galvanised, tube Ø: 42 mm

Order no.	Adjustable range mm		Combi pin
	From	to	Groove: 11 mm Pin Ø: 19/24 mm
00252211	2360	2760	



### PARTING WALL LOCK / TENSIONING BOARD Aluminium

Order no.	Adjustable range mm	
	From	to
00225385	2400	2700



**Branding** KFI CARGO CONTROL

Order no.	Spare part
00225501	A Spare rubber, tension board, internal
00253098	B Spare rubber, header
00225507	C Spare header



### COMBI LASHING TRACKS

Galvanised, length 3 m, weight 6.6 kg

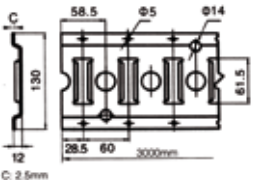
Order no.	Diagram
00259992	 <p>Dimensions: 130, 12, 28.5, 60, 3000mm, 58.5, Ø5, Ø14, 61.5, C: 2.5mm</p>



### KEYHOLE LASHING TRACKS

Galvanised, length 3 m, weight 6.4 kg

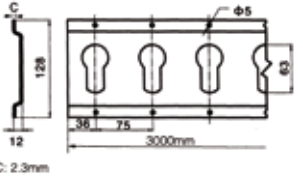
Order no.	Diagram
00259993	 <p>Dimensions: 128, 12, 36, 75, 3000mm, Ø5, 62, C: 2.3mm</p>



## ROUND SLINGS

**We also supply HEAVY-DUTY round slings!**

- Made in Europe
- Outstanding quality
- Safety factor 7:1
- Made in acc. with standard EN 1492-2
- 100% polyester
- Finely crafted
- Top material quality

- Extremely abrasion-resistant, reliable
- Excellent handling when threaded in
- **Teflon-coated**, water- and oil-repellent
- With operating manual enclosed
- **DGUV-certified**



## STRETCH ROUND SLINGS with 'Dyneema® sheath' – round sling 'RS KOMPAKT'

- Safety factor 7:1
- Highly compact
- Extremely easy to handle
- Also suitable for especially small hooks

- Advantage: Stiffness thanks to the sheathing's elastic yarn
- Makes handling much easier during anchorage (e.g. tighter anchorage points, narrow gaps, confined spaces, working at a height)

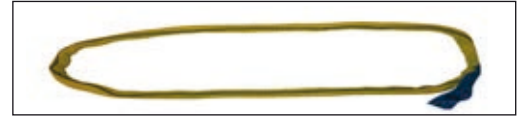





## LIFTING STRAPS

- Polyester
- To EN 1492-1

- Safety factor 7:1
- Two-layer design





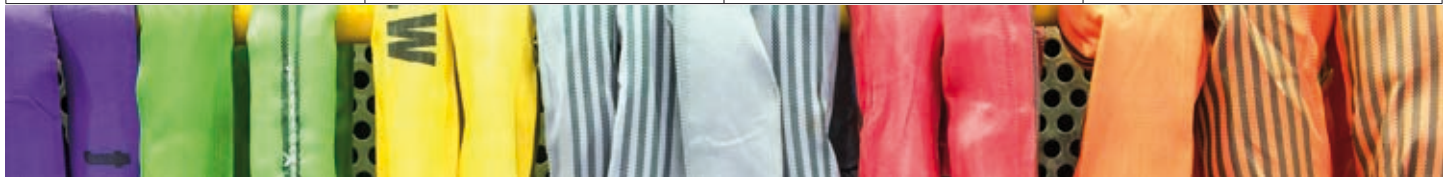

### Colours and load-bearing capacities:

1T VIOLET 	2T GREEN 	3T YELLOW 	4T GREY 
5T RED 	6T BROWN 	8T BLUE 	10T ORANGE 



### Load capacity table, round slings and lifting straps, EN 1492

Colour	Direct kg	Looped kg	Wrapped kg	Wrapped around kg	
	0°	0°	0°	Up to 45°	45–60°
					
Violet	1,000	800	2,000	1,400	1,000
Green	2,000	1,600	4,000	2,800	2,000
Yellow	3,000	2,400	6,000	4,200	3,000
Grey	4,000	3,200	8,000	5,600	4,000
Red	5,000	4,000	10,000	7,000	5,000
Brown	6,000	4,800	12,000	8,400	6,000
blue	8,000	6,400	16,000	11,200	8,000
Orange	10,000	8,000	20,000	14,000	10,000

**We supply lifting straps with load-bearing capacities from 500 kg to 25 t, with two to four layers!**

**For items not listed, please send us a request!**



**CHAIN SLING** with any hook, in any length, for any load**1-strand** 1 m useful length (UL)

	Order no.			Chain	Load capacity kg
	Chain	+ hook	+ claw	Ø mm	Direct
	00234525	00232020	00252684	6	1120
	00231448	00251254	00252685	8	2000
	00234706	00252682	00252686	10	3150
	00230953	00249640	00252687	13	5300

**2-strand** 1 m useful length (UL)

	Order no.			Chain	Load capacity kg	
	Chain	+ hook	+ claw	Ø mm	>0-45°	>45-60°
	00230706	00252693	00252695	6	1600	1120
	00226173	00252573	00229754	8	2800	2000
	00249977	00249641	00252696	10	4250	3150
	00235597	00252694	00252697	13	7500	5300

**4-strand** 1 m useful length (UL)

	Order no.			Chain	Load capacity kg	
	Chain	+ hook	+ claw	Ø mm	>0-45°	>45-60°
	00232005	00232806	00249815	6	2360	1700
	00233723	00252743	00252300	8	4250	3000
	00252738	00252744	00252301	10	6700	4750
	00252739	00252745	00252749	13	11200	8000

**SMALL RATCHET LEVER HOIST** - 1.5 M





	Order no.	Load capacity	No. chain strands
		kg	
	00225497	750	1
	00225498	1500	1
00225499	3000	1	

**MANUAL CHAIN HOIST** - STROKE 3.0 M

	Order no.	Load capacity	No. chain strands
		kg	
	00225487	1000	1
	00230684	2000	2
00225489	3000	2	



For items not listed, please send us a request!

## FULL BODY HARNESSSES / FALL PROTECTION EQUIPMENT to EN 361/358

	Order no. size 48-56	Order no. size 54-62	Colour	Equipment
			Shoulders/legs	
	00251839 (universal size)		Red/green	Without lap belt, D-ring in back section, continuously adjustable leg belts, chest belt with quick release coupling, belt width 45 mm
	00255168	00255169	Red/black	Lap belt, fall-arrest eyelet front + back, adjustable shoulder belts and leg belts, adjustable pelvic belt, adjustable height of front fall-arrest eyelet
	00256701 (universal size)		Green/red	Without lap belt, D-ring in back section, two D-rings on retention belt, wide, padded back section, continuously adjustable leg belts, chest belt with quick release coupling, belt width 45 mm
	00257088	00257089	Red/black	Lap belt, fall-arrest eyelet front + back, back section 100 mm padded with side retention eyelets, adjustable shoulder belts and leg belts, adjustable pelvic belt, adjustable height of front fall-arrest eyelet

## SHOCK ABSORBER to EN 354 / 355

- Fastener with integrated shock absorber
- Plaited polyamide rope, Ø 12 mm

1	2	3	Order no.	Length	Karabiner	Equipment	Image
				m			
			00250440	1.5	2x M10	Single-strand, fixed length	1
			00255175	2.0			
			00255173	1.5	1x M10, 1x M65		2
			00255185	2.0			
			00255174	1.5	1x M51, 1x M65		3
			00255186	2.0			

**PLATE CLAMP WITH PIVOTING EYELET**

Order no.	Load-capacity	Clamp width
	t	mm
00000935	0.5	0–15
00000936	1.0	0–20
00000937	2.0	0–25
00000938	3.0	0–30
00000939	5.0	0–50

**BEAM CLAMP**

Order no.	Load-capacity	Clamping range
	t	mm
00000930	1.0	75–230
00000931	2.0	75–230
00000932	3.0	80–320
00000933	5.0	90–310

**PUSH TROLLEYS**

Order no.	Load-capacity	Clamping range
	t	mm
00000890	0.5	64–220
00000891	1.0	64–220
00000892	2.0	88–220
00000893	3.0	102–220



**TRANSPORT CLAMP / SLING SWIVEL**

- Ball-bearing-mounted for simple load alignment
- Grade 8
- Rotates 360°
- Eyelet swivels 180°

	Order no.	Load capacity	Size DxL
		kg	mm
	00000522	500	12x18
	00000525	1120	16x20
	00000527	2000	20x30
	00000528	3150	24x30
	00000536	5300	30x38

**SHACKLE WITH SCREW BOLT/EYEBOLT** cambered form

- High-strength, tempered steel
- Galvanised bracket
- Safety factor > 5

	Order no.	Load capacity	Dimensions mm	
		kg	C	E
	00000808	2000	21	16
	00000809	3250	27	20
	00000810	4750	32	22
	00000811	6500	36	27
	00000812	8500	43	28
	00000813	9500	46	33
	00000814	12000	52	35
	00000815	13500	57	38
	00000816	17000	60	42
	00000817	25000	73	50

Available load capacity: 300 kg to 55,000 kg!

## CLEANING PAPER ROLLS – BLUE

	Order no.	Ply	Width of layer, cm	No. sheets	Width cm	Rolls per unit
	00225877	2	22	1000	36	2
	00225876	2	36	1000	38	2
	00225875	3	36	1000	36	1

## PAPER TOWELS – 5000 TOWELS Disposable, Z-fold

	Order no.	Ply	Colour	Width of layer, cm
	00225964	1	Undyed white	25x23

## SELECTION FROM OUR UTILITY VEHICLE PARTS RANGE

From the areas: PLASTIC – HYDRAULICS – METAL – LIGHTING and SAFETY



Use our  
**consultation hotline:**  
+49 (0) 6831 76889 -30

### KFI Cargo Control GmbH

Röntgenstraße 1  
66763 Dillingen  
Tel.: +49 (0) 6831 76889 - 30  
Fax: +49 (0) 6831 76889 - 33  
info@kfi-cargo.com  
www.kfi-cargo.com

**Delivery conditions:** For each assignment, we charge a packaging and processing fee of 1.64 EUR net.

For net goods values of €1,300 or more: delivery carriage free, except for bulky goods and anti-slip mats. Below €1,300: 8% of net order value, €9.80 minimum, except for **bulky goods and anti-slip mats: delivery ex works!**

**Delivery service:** We deliver with a parcel delivery service within 1–2 workdays OR with a road haulage company – on request by 10.00 a.m. the following workday OR express. Subject to change without notice. Errors and omissions excepted. Products may differ slightly from illustrations.